

CSP-dot Series Specification

# PD140

## 48V-10mm



## 【General description】

- 36m long strip driven by one end power supply
- The EFW process has a unique structure, using special profiles, does not require adhesive backing, and is easy to install
- Side-exit cable plug, seamless lighting with no dark spots
- Life longer than 54000H, Ta: -40-60°C; Tc: 75°C (max)
- 5 years warranty

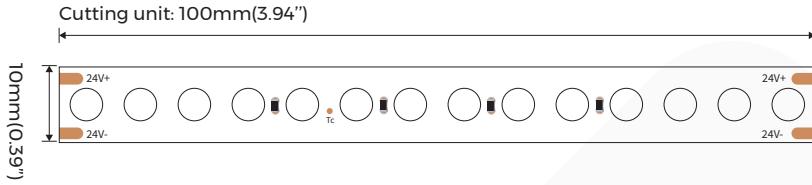
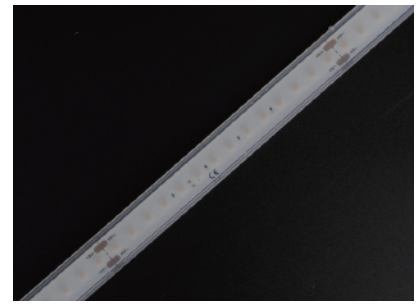

## 【Dimension】

- |                                   |  |
|-----------------------------------|--|
| Input voltage: DC48V              | Max.length: 36000mm(118.1')            |
| CRI: 90                           | Cutting unit: 100mm(3.93 ")            |
| Max.power: 11W(1m) 5.5W(1m)       | LED pitch: 7.14mm(0.28")               |
| Power range: 9-11W(1m)            | Min. bend diameter: $\Phi$ 60mm(2.36") |
| 4.5-5.5W(1m)                      | Mounting: 3M tape                      |
| Rated current: 0.21A(1m) 0.1A(1m) | Copper foil: 3oz                       |
| Typical Power: 11W(1m) 5.5W(1m)   |  |
| tape IP: IP20/IP67                |  |
| On-off times: 10000 (test times)  |  |
| Warranty: 5years                  |  |

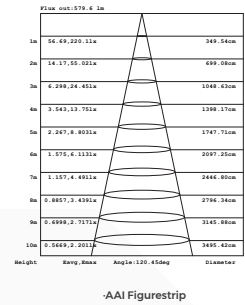
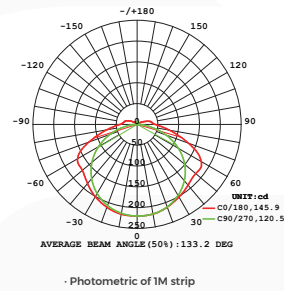

## 【Photo-electric Parameters】

CRI	Color	CCT	Lumen(lm/m)	Lumen(lm/ft)	lm/W	ErP 2019
Ra>90	SW(10W)	2700K	880	268	88	G
Ra>90	WW(10W)	3000K	910	277	91	G
Ra>90	NW(10W)	4000K	940	286	94	F
Ra>90	W(10W)	6500K	840	256	84	G
Ra>90	SW(5W)	2700K	425	129	85	G
Ra>90	WW(5W)	3000K	440	134	88	G
Ra>90	NW(5W)	4000K	445	135	89	G
Ra>90	W(5W)	6500K	430	131	86	G

- 1.The tolerance of output data can be vary up to 15%.
- 2.the output data tested according to IES TM-30-15.
- 3.the output data is based on IP20/1mterter, data of 5m in only for reference.
- 4.IP protection process leads changes to size, CCT and luminous flux.



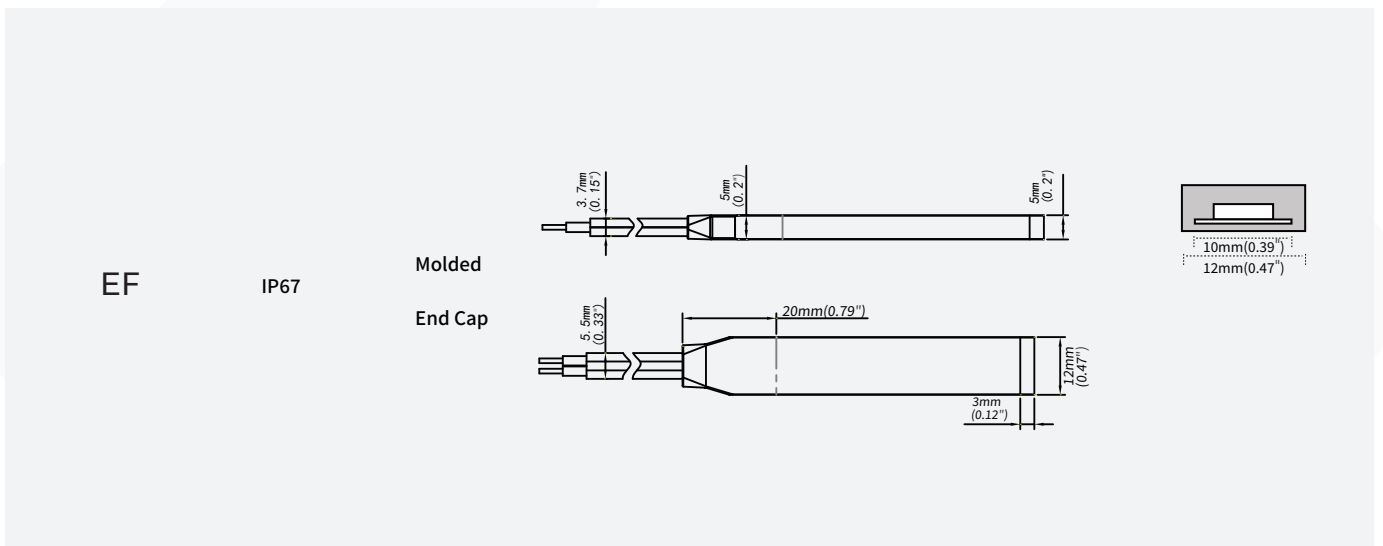
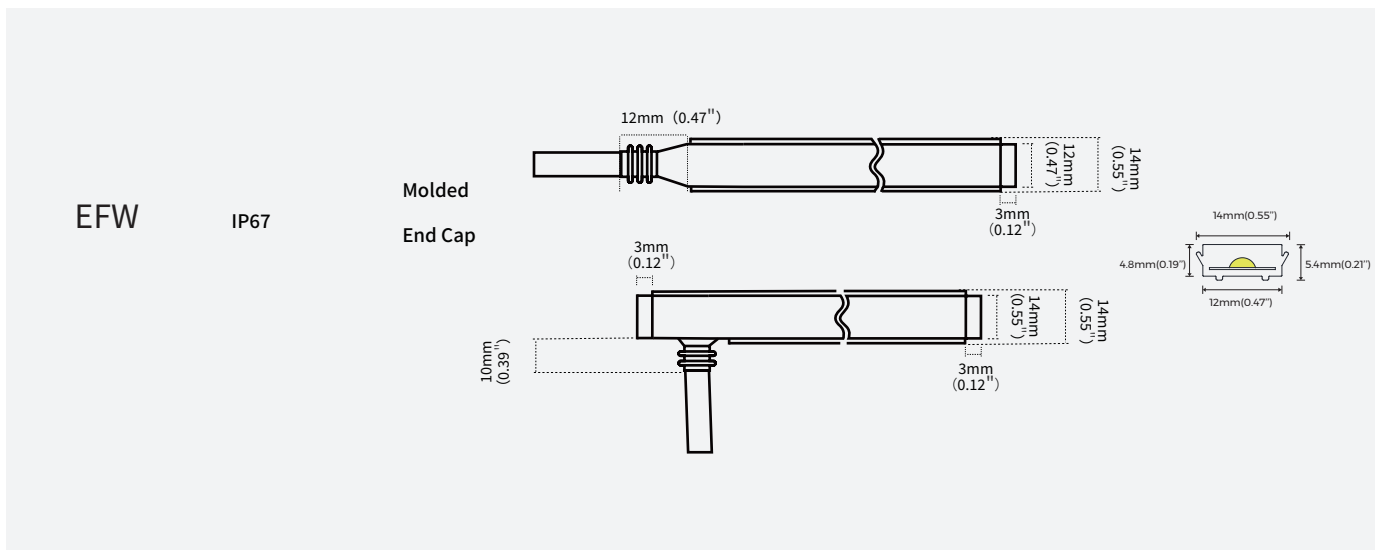









**[IP process information]**



**[Electronic & output data]**

IP Process	Picture	Picture description	Size	optional CCT/color for finished product	lumen output rate
NO		No proof	10mm*1.7mm	2700K/3000K/4000K/6500K	100%
EFW		No proof	14mm*5.4mm	2700K/3000K/4000K/6500K	86%
EF		No proof	12mm*5mm	2700K/3000K/4000K/6500K	86%

## [Product Solutions]

Name	Picture	Code	coding	description
Alumina carrier		/	CLS10EFW-12050100	size:L1000*W15.4*H7.4mm
Aluminum clip		/	FLS10EFW-1205	size:L25*W15.4*H7.4mm
2P male connector wire		/	AS-FC-0009(0.25M) AS-FC-0010(0.5M) AS-FC-0011(2M)	suitable for monochromatic led strip Wire lengths are optional:0.25M/0.5M/2M
2P female connector wire		/	AS-FC-0012(0.25M) AS-FC-0013(0.5M) AS-FC-0014(2M)	suitable for monochromatic led strip Wire lengths are optional:0.25M/0.5M/2M
2P T-Connection Wire		/	AS-FC-0027	Suitable for monochromatic led strip Wire length 150mm,IP67
Fixed Clip		94-02-00-0003	FSW10SA	Silicone clip, screw: PA 3*8mm, suitable for 10mm FPC,EF/ET strip
Silicone Plug Kit		94-02-00-0046	DT10EA-A	Silicone plug kit is suitable for 10mm board width, ET/EF series silicone extrusion light strip
Silicone stopper kit		94-02-00-0047	DW10EA-A	Silicone tail plug kit is suitable for 10mm board width, ET/EF series silicone extrusion light strip
Mounting groove		94-02-00-0025	CVT10EA-14100100	Transparent PVC mounting groove,suitable for 10mm FPC,silicone extruded EF/ET strip
Stopper glue		94-16-03010001	AS-PG-0003	Silicone gel,suitable for ET/EF/EG waterproof LED strip
Monochrome remote		/	R6-1	output signal: RF Working voltage: 3VDC(CR2032) Remote control distance: 30m Working temperature:Ta:0-30 C~0+55 C
Monotone light controller		/	CRI-GBA	Input voltage: DC12-48V Output current: 15A@12V/24V,10A@36V/48V Output Power: Max 180W@12V/Max 360W @24V/Max 360W@36V/Max 480W@48V Working temperature: -30 C~ +55 C

## [Packing]

Colors brand package(NONA)

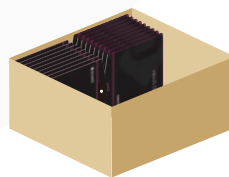

General customized package(EF/EFW)

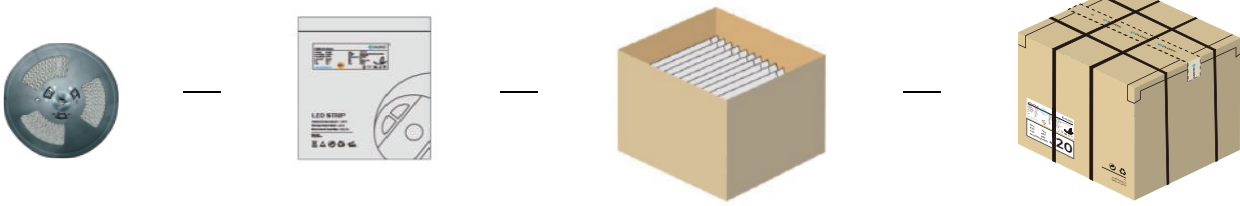

IP Process	Product size(mm)	Product quantity (m/reel)	Product quantity (m/case)	Product net weight(kg)	Net weight per box(kg)	Gross weight(kg)	Package size (cm)
NO	35000*10*1.7	10	350	0.5	5	6.2	41*41*26
EFW	35000*14*5.4	35	35	3.5	3.5	4.4	25*25*26
EF	35000*12*5	35	35	3.3	3.3	4.2	25*25*26

Remark: data with 10% tolerance

### 【Precautions】

- Please drive the led strip with 24VDC isolated power, and the ripple of the constant voltage source should be less than 5%.
- Please do not bend the strip into an arc with a diameter less than 60mm to ensure the longevity and reliability.
- Do not fold it in case any damage of LED beads.
- Do not pull the power wire hard to ensure the longevity. Any Crash may damage the LED light is prohibited.
- Please make sure the wire is connected to the anode and cathode correctly. The power output should be consistent with the voltage of the strip to avoid damage.
- LED lights should be stored in dry, sealed environment. Please only unpack it before usage. Ambient temperature: -25°C~40°C. Storage temperature: 0°C~60°C. Please use the strips without waterproof within indoor environment with humidity less than 70%.
- Please be careful during operation. Do not touch the AC power supply in case of electric shock.
- Please leave at least 20% power for the power supply during using to ensure there is enough power supply to drive the product.
- Do not use any acid or alkaline adhesives to fix the product (e.g.: glass cement).
- Do not scratch the product when IP process of the product is NA. Ultraviolet rays will damage the nano-layers on the product and seriously affect the life of the product.